

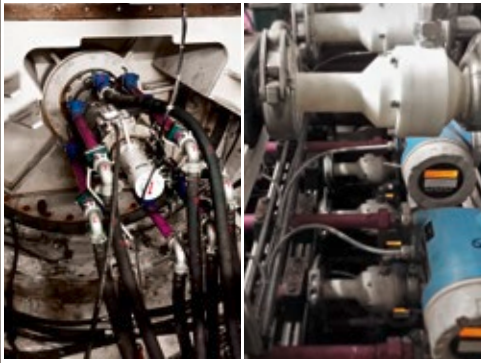

Product Systems for Tunnel Construction

EXPERTISE
TUNNELLING





Soil conditioning systems

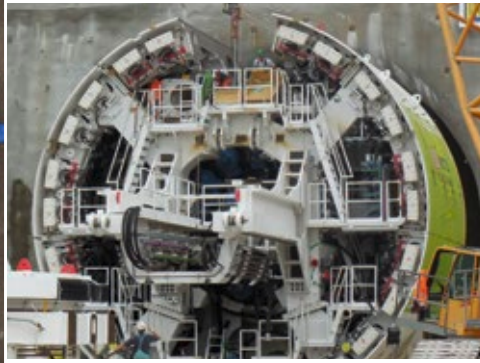

Drive supporting measures and backfill grout mortars



Product systems for the manufacture of tunnel segments

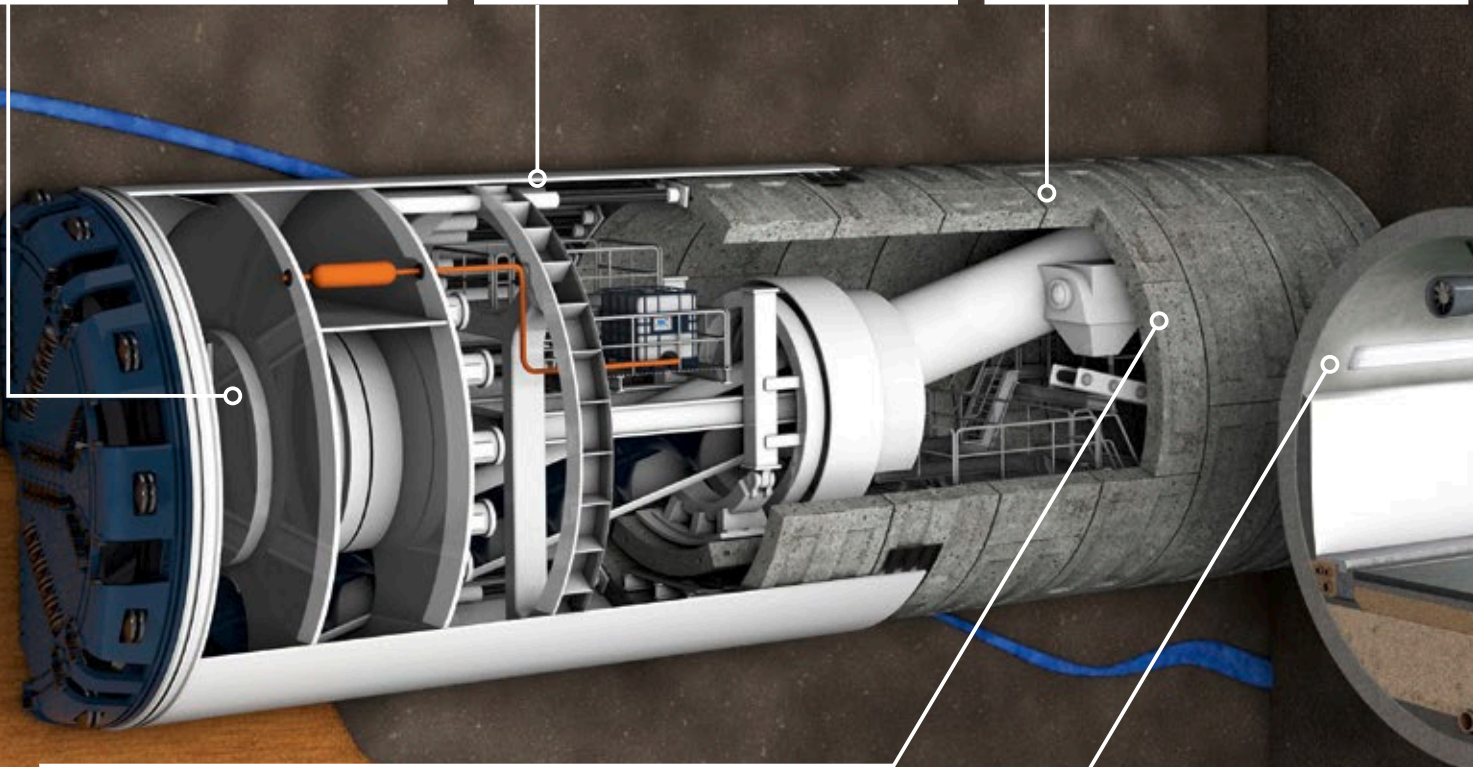

Injection systems for waterproofing, filling and sealing of cracks and cavities



Solutions for shotcrete and tunnel lining applications



Concrete replacement and surface protection



System solutions for mechanised and conventional tunnel construction

MC is your single-source partner for tunnel projects. We offer comprehensive system solutions covering all fields of tunnel construction – from driving to repair. With our decades of experience in major international projects, we are able to supply effectively optimised project-specific product systems geared to securing your full satisfaction.

Mechanised Tunnel Construction	04 – 19
Mechanised tunnelling	06 – 13
Soil conditioning	06 – 07
Shield tail sealing	08 – 09
Annular gap grouting	10 – 11
Tunnel segment technology	12 – 17
Tunnel segment production	12 – 15
Concrete reprofiling	16 – 17
Machine technology and equipment	18 – 19
Conventional Tunnel Construction	20 – 27
Shotcrete	22 – 23
Sealing systems	24 – 25
Lining	26 – 27
Attendant Measures and Repairs	28 – 42
Attendant measures	30 – 33
Soil stabilisation	30 – 31
Soil sealing	32 – 33
Rehabilitation	34 – 41
Curtain and joint sealing	34 – 35
Crack and cavity repair	36 – 37
Concrete repairs	38 – 39
Surface protection	40 – 41
Service and support	42

Mechanised Tunnel Construction

The inherent safety and efficiency of mechanised tunnelling makes it particularly suitable in difficult geological formations and in inner-city projects. Aside from the gripper and slurry methods, EPB technology (earth pressure balance) is especially important as it offers certain economic advantages in tunnel boring. Success depends not only on careful planning and execution, but also – and critically – on ensuring optimum interaction between the machine technology employed and the speciality chemistry of the systems supporting it.

With our expertise in all areas of soil conditioning, shield skin lubrication, shield tail sealing, backfill grout mortars and tunnel segment construction and waterproofing, MC is able to assist you in finding the ideally matched system solutions for your tunnel boring operations.



Mechanised tunnelling

EPB (Earth Pressure Balance Shields) are being increasingly used, even in geological formations that are difficult to penetrate. Soil conditioning and attendant measures are therefore also becoming ever more important. Modern conditioning agents and technologies are the key to successful EPB tunnelling.

Superabsorber

MC-Montan Drive LB 02

- Optimised conditioning of soils with high water contents
- Protection against water ingress from highly permeable soils
- Exceptional water binding properties
- Improved soil removal from the excavation chamber and screw conveyor

Defoamer

MC-Montan Drive DF

- Fast reduction of foam formation in the event of over-dosing
- Cleaning of foam-forming surfaces
- High level of sustainability/environmental compatibility

Soil conditioning for EPB shield TBMs

The efficient use of earth pressure balance shields requires an even-pressure support of the work face. Soil conditioning has to be carried out in order to meet the requirements placed on the excavated soils serving as the support medium. The aim is to ensure their appropriate flow behaviour, their ability to transmit the support pressure, reduce water permeability, increase drainage resistance and reduce the internal angle of friction.

Aside from enhancing safety and increasing tunnel driving progress, suitability for landfill and reusability of the conditioned soil are becoming ever more important factors. Hence, conditioned soil also has to meet certain geotechnical and environmental requirements as well.

MC offers conditioning agents specifically adapted to geological conditions, enabling you to achieve high tunnelling advance rates with a good degree of reliability. And in terms of ecological and environmental compatibility, too, you will always be on the safe side with MC systems.

Foam concentrate

MC-Montan Drive FL 02

- Reduced energy consumption thanks to minimised cutting head torque
- Conditioned soil offering optimised flow and conveyance
- Reduced wear of the cutting tools
- Environmentally friendly and readily biodegradable

MC-Montan Drive FL 04

- Minimisation of adhesion and agglomeration in the excavation chamber and screw conveyor
- Reduced wear in the cutting tools
- Economic and technically efficient dosages
- Environmentally friendly and readily biodegradable

Anti clogging agent

MC-Montan Drive CA 01/CA 02

- Minimisation of adhesion and agglomeration in the excavation chamber and screw conveyor
- Reduced wear in the cutting tools
- Reduced energy consumption thanks to minimised cutting head torque
- Environmentally friendly and readily biodegradable



Shield tail and annular gap sealing

A major component of the sealing concept of a tunnel boring machine is the shield tail which, equipped with pilaster strips, serves to inject backfill grout mortar into the annular gap. Backflow of the backfill grout mortar and penetration of pressurised water are prevented by brush seal elements in combination with shield tail sealing compounds.

Particularly under very high water pressures, leaks in this system can jeopardise the safety of the entire project. Additional protection against the penetration of water is provided by a travelling annular gap and soil injection system using soft elastic sealant materials.

Sealing & lubricant agent

MC-Montan Seal ST

- Shield tail sealing and lubrication for safe and reliable driving operations
- Protection against water and mortar ingress even at very high pressures
- Outstanding pumpability (optimised for use in combination with HDT-Montan Device HD)
- High level of sustainability/environmental compatibility

Temporary shield tail sealant

MC-Montan Injekt TR-X

- Soft-elastic, swelling injectable shield tail sealant for temporary protection
- Short, controllable reaction times for optimum sealing results
- Readily usable in conjunction with annular gap grouting mortars thanks to exceptional alkali resistance
- Sustainable and environmentally compatible in contact with soil and groundwater

MC-Montan Injekt CF

- High expanding dry for effectively sealing and stabilising of soil and rock
- Short reaction time with significant volume increase irrespective of water presence
- Promotes optimum excavation and conveying properties of the injected soil
- Groundwater-neutral injection substance for use in dry, damp and water-filled cavities
- Optimum solution for additional shield tail sealing precautions



Individually formulated grouting mortar systems for reliably stabilised tunnel profiles

The annular gap that results during tunnel driving between the tunnel lining and the soil is filled with grouting mortar to minimise surface settlement and stabilise loose soil. Injected into the annular gap over the full area, the mortar is formulated for stiffness and strength values aligned to those of the surrounding soil.

MC has a range of one-component and two-component backfill grout mortars formulations that can be specifically aligned to the in-situ soil conditions specific to your tunnel construction project. This means that every tunnel profile is provided with the optimum bedding solution for minimum settlements and high heading rates.

Aktivator

MC-Montan Grout 01

- Speciality activator for backfill grout mortar systems
- Exceptionally high reactivity
- Gel phase initiated in line with project-specific requirements

Stabiliser

MC-Montan Grout 02

- Highly effective stabiliser for backfill grout mortar systems
- Optimised mortar conveying and pumping properties thanks to dispersive effect
- Controllable, extended application times
- High level of sustainability/environmental compatibility

Alkali-activator

MC-Montan Grout AA 03

- Alkali-activated two-component backfill grout mortar systems
- High sulphate and chloride resistance
- Inactive as-supplied mixture
- Direct initiation of the gel phase with minor exothermic development

Viscosity modifier

MC-Montan Grout 05

- Viscosity modifier and injection aid for backfill grout mortar systems
- High early strength values for fast achievement of the required bedding properties
- Accurately controllable consistency
- Ideal for undrained rock conditions

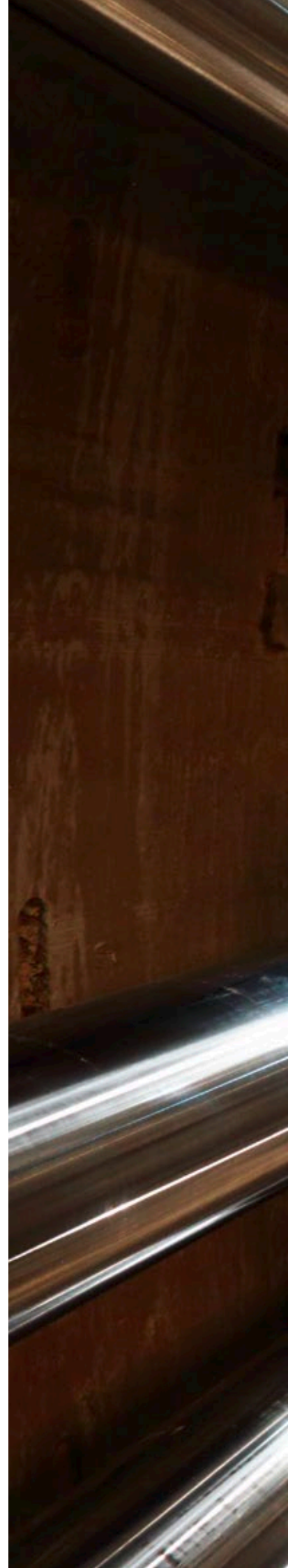



Tunnel segment technology

In mechanised tunnelling, tubings of segment construction serve to both stiffening and sealing. Consequently, these precast concrete elements have to meet the very highest of quality demands.



Maximum concrete quality and durability

Tunnel segments are subjected to the highest demands on quality and durability. They have to be able to withstand not only the forces imposed upon them by the surrounding soil but also the pressures generated during the tunnel driving operation. Properly reinforced designs based on high-performance concrete are therefore essential.

MC is able to offer you an integrated solution individually aligned to your project. Working in close collaboration with you, our concrete technologists and allied experts will put together a tailored system solution from our comprehensive product portfolio, helping you to meet even the highest demands on quality and durability.

Superplasticiser

MC-PowerFlow

- Superplasticiser for maximum quality demands on the concrete and the final finish
- Exceptionally high water-saving potential
- Fast strength development for high early strength values and early formwork stripping
- Free of corrosive components

Hardening accelerator

Centrament Rapid

- Special hardening accelerator for controllable, reduced curing times
- Very high early strength combined with minimal decrease in final strength values
- Reduced cycle times even at low temperatures
- Free of chlorides and corrosion-promoting components



Superplasticiser MC-PowerFlow

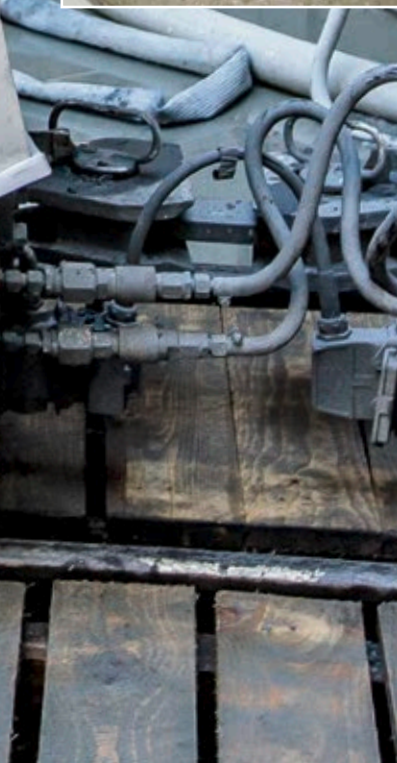

Retarder

Centrament Retard

- Setting retarder of the latest generation
- Long-lasting, good flowability for high concrete quality
- Optimum concreting conditions thanks to extended application times
- Free of chlorides and corrosion-promoting components

Stabiliser

Centrament Stabi

- Special stabiliser for highly fluid concretes
- Minimisation of the internal frictional forces of the concrete mix
- Optimised protection against sedimentation and blooming
- Exceptional concrete homogeneity

Air-entraining

Centrament Air

- Air-entraining agent for homogeneous concrete mixtures and reduction of tendency towards segregation
- Efficient introduction of microporosity in the concrete structure
- Outstanding application and compaction properties
- Free of corrosion-promoting components

Concrete admixture

Centrilit NC

- Concrete admixture for outstanding homogeneity and chemical resistance
- Reduced chloride migration and improved abrasion resistance thanks to increased concrete density
- Suitable for a wide range of applications including high-performance concretes
- High level of sustainability/environmental compatibility

Release agent

Ortolan Basic/Classic/Extra

- Concrete release agents with integrated corrosion protection for outstanding surface finishes
- Exceptional separation effect with minimum concrete residues on the formwork
- Universally applicable for all absorbent and non-absorbent formwork
- Sustainable, environmentally compatible and biodegradable



Centrilit NC –
pozzolanisches Aluminosilikat

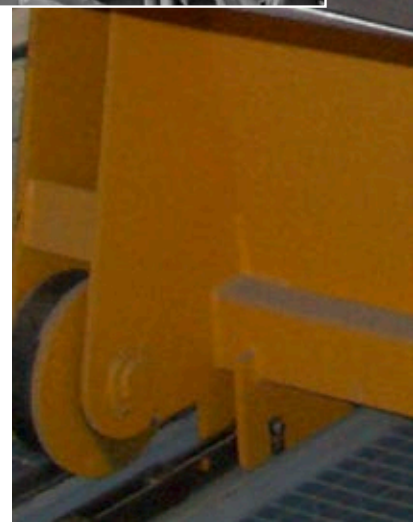



TCL
Sistema C-1000
Sistema M-1000
[Barcode]



Concrete repairs and concrete cosmetics for a perfect finish

Once installed, tunnel segments are exposed to huge loads. Any incorrect placement of the segment in the annular assembly or its displacement due to external forces can result in the concrete spalling. The comprehensive range of reprofiling solutions available from MC means you have at your disposal all the high-performance products needed, including for concrete cosmetics.

Concrete replacement

Nafufill KM 250

- One-component concrete replacement system for manual and spray application
- Chloride-proof and resistant to de-icing salts
- Fire resistance rating F 120 to DIN 4102-2
- Fire resistant according to the Tunnel Fire Curves issued by Germany's ZTV-ING, the EBA Code of Practice for Railway Tunnels and the TNO Report issued by the Rijkswaterstaat (RWS) of the Netherlands
- Certified to EN 1504-3, Class R4 – structurally relevant

Coarse filler

Emcefix-Spachtel G extra

- Polymer-modified coarse filler for concrete cosmetic purposes
- Bond coat integrated
- Resistant to freeze-thaw cycling and extreme temperatures
- Certified to EN 1504-3, Class R2 – structurally irrelevant

Fine filler

Emcefix-Spachtel F

- Polymer-modified fine filler for concrete cosmetic purposes
- Available in 7 colours
- For layer thicknesses up to 6 mm
- Certified to EN 1504-3, Class R1 – structurally irrelevant

Thermal filler

Nafuquick HT

- Polymer-modified thermal filler for concrete cosmetic purposes
- Exceptional water retention capacity eliminates need for additional curing agents
- Thixotropic, highly stable and suitable for overhead work
- Suitable for substrate temperatures up to +70 °C
- Certified to EN 1504-3, Class R1 – structurally irrelevant



Integrated systems from a single-source

MC offers you a complete, integrated system comprising both the requisite machine technology and the speciality additives you need to achieve the highest performance in terms of soil conditioning. Through the use of the HDT-Montan Device CT, you are able to create mono-cellular foam of optimum quality for outstanding conditioning results, even under difficult geological conditions. Each integrated system is specifically adapted to the geology of your project.

Foamtube

HDT-Montan Device CT

- Reliable and adaptable to even difficult geological conditions
- High-performance integrated system in combination with MC-Montan Drive products
- Reduction of material and energy consumption levels thanks to patented conditioning technology

For shield tail sealing, too, it is essential not only to have high-performance sealing compounds but also optimised pump and conveying technology. Our speciality pump and sealants ideally matched to it ensure the shield tail remains impermeable.

Lubricant pump

HDT-Montan Device HD

- Speciality pump for conveying high-viscous media
- Particularly low maintenance due to high chemical and mechanical resistance
- Low space requirement
- Easier change of barrels thanks to innovative Fast-Change-System



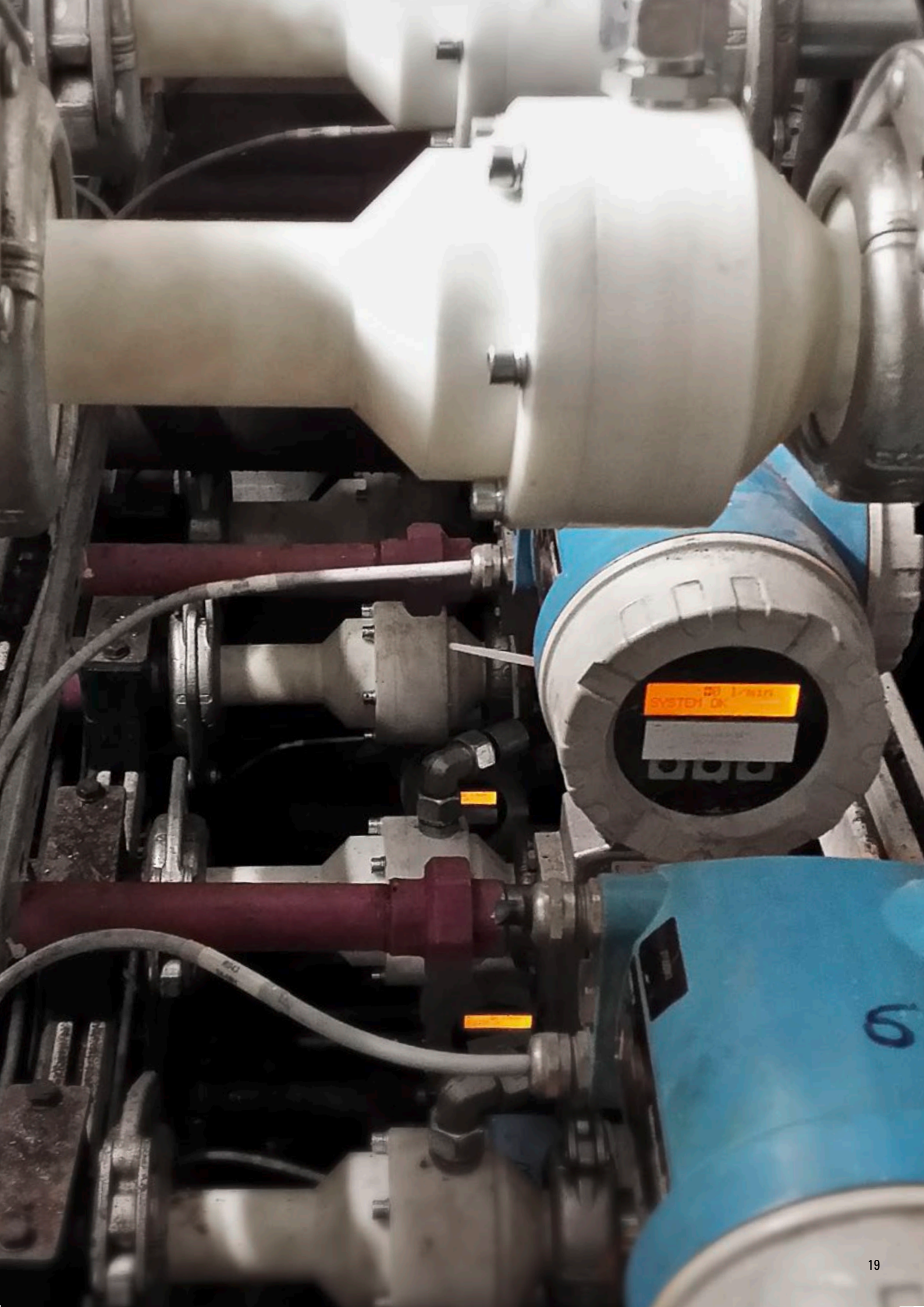



Conventional Tunnel Construction

Conventional tunnelling using mining techniques is still encountered in infrastructure projects around the world. Conventional tunnel construction has always represented a significant engineering challenge, demanding from all participants a high degree of technical expertise, care and attention. The methods that fall under this heading range from soft ground to drill-and-blast tunneling in hard rock.

Conventional tunnel construction imposes the most exacting of standards on the temporary and permanent consolidation and shoring, the lining work and the waterproofing solution selected. Hence MC offers a portfolio with in-built adaptability, allowing our product systems to be effectively aligned to your particular tunnel project. Thus, even before the tunnelling work begins, you can be sure that the quality and reliability you require are readily to hand.

Maximum quality for the highest shotcreting standards

Inherently flexible, shotcrete accommodates conditions as they change. Shotcrete is used primarily as a temporary means of consolidating and sealing the in-situ material and for smoothing the excavated sections. As a means of rock edge reinforcement, it also serves to close gaps and prevent small cavities from forming as a result of the arching effect in the profile.

Shotcrete can be manufactured in a variety of ways. The processes differ in terms of the admixtures used, the initial materials and the way the shotcrete is delivered. In the dry spray process, a dry mixture is pumped using the thin-stream technique to the nozzle where it is then wetted with water. In the wet spray process, a supply mixture is generally delivered using the thick-stream technique to the nozzle where it is mixed with a hardening accelerator and air.

Accelerator

MC-Montan Shotcrete HA

- High-performance shotcrete accelerator for optimum control of strength development
- Very high early strength values combined with minimal decrease in final strength values
- Also able to accelerate concretes of higher consistency
- Free of chlorides and corrosion-promoting components





Superplasticiser

MC-PowerFlow SC 21

- Superplasticiser based on MCP technology for shotcrete delivery mixtures
- Exceptionally long-lasting liquefaction and optimised stabilisation with high consistencies
- Simple and fast intermixing for optimum concrete homogeneity
- Cost-efficient dosage and high water-saving potential

Retarder

Centrament Retard VZ 81

- Speciality retarder for shotcrete
- Optimum application times thanks to long-lasting, accurately controllable setting retardation
- Simple and fast intermixing for optimised homogeneity of the concrete and maximum efficacy
- Free of corrosion-promoting components
- Suitable for concretes according to Germany's DAfStb and ZTV-ING codes of practice

Concrete admixture

Centrilit NC

- Concrete admixture for maximum homogeneity and chemical resistance
- Reduced chloride migration and improved abrasion resistance thanks to increased concrete density
- Versatile applicability, also suitable for high-performance concretes
- High level of sustainability/environmental compatibility

Setting accelerator

Centrament Rapid

- Speciality setting accelerator for controllable, reduced binding times
- Very high early strength values combined with minimal decrease in final strength values
- Reduced cycle times even at low temperatures
- Free of chlorides and corrosion-promoting components



Tunnel sealing systems – permanently watertight and highly resistant

Whether for cross-cuts, galleries, access points, adits or entire tunnel sections, MC is able to provide you with exactly the right waterproofing solution for your tunnel construction project. Sealing in conventional tunnelling is provided by plastics waterproofing sheet or sprayable waterproofing membranes. Both systems have a common objective – to ensure that the tunnel remains dry over its planned service lifetime exceeding 100 years. This objective places particularly high requirements on the sealing systems. They are expected to protect the support structure and technical installations while at the same time ensuring disruption-free operation. Hence they need to be able to both withstand chemical attack and resist mechanical stress phenomena.

Particularly in the area of station structures, galleries or access tunnels, that is to say where geometries become difficult, high-performance and flexible sealing systems are essential.

Sprayable waterproofing

MC-Montan Shot Seal

- Highly flexible, dry-spray waterproofing membrane
- Outstanding resistance to alkalis UV and weathering
- Sandwich possible between two shotcrete layers
- Very high adhesion to concrete, steel and plastics sheeting
- Permanently impervious to pressurised water and diffusion

Durable concrete quality with optimised application properties

The final support measure in conventional tunnel construction frequently takes the form of an inner shell or lining created using in-situ concrete. However, the project-specific requirements may vary considerably. MC therefore offers you individualised concrete formulations specifically adapted to your requirements.

The concrete for this lining has to meet both specific application requirements to ensure ease of placement, and exacting durability demands. The prevailing exposure classes and conditions under which construction takes place will affect the concrete formulation, the quality of which is critical to the success of your project.

Superplasticiser

MC-PowerFlow SC

- Superplasticiser for maximum quality demands on the concrete and the final finish
- Exceptionally high water-saving potential
- Fast strength development for high early strength values and early formwork stripping
- Free of corrosion-promoting components

Retarder

Centrament Retard VZ 81

- Speciality retarder for shotcrete
- Optimum application times thanks to long-lasting, accurately controllable setting retardation
- Simple and fast intermixing for optimised homogeneity of the concrete and maximum efficacy
- Free of corrosion-promoting components
- Suitable for concretes according to Germany's DAfStb and ZTV-ING codes of practice



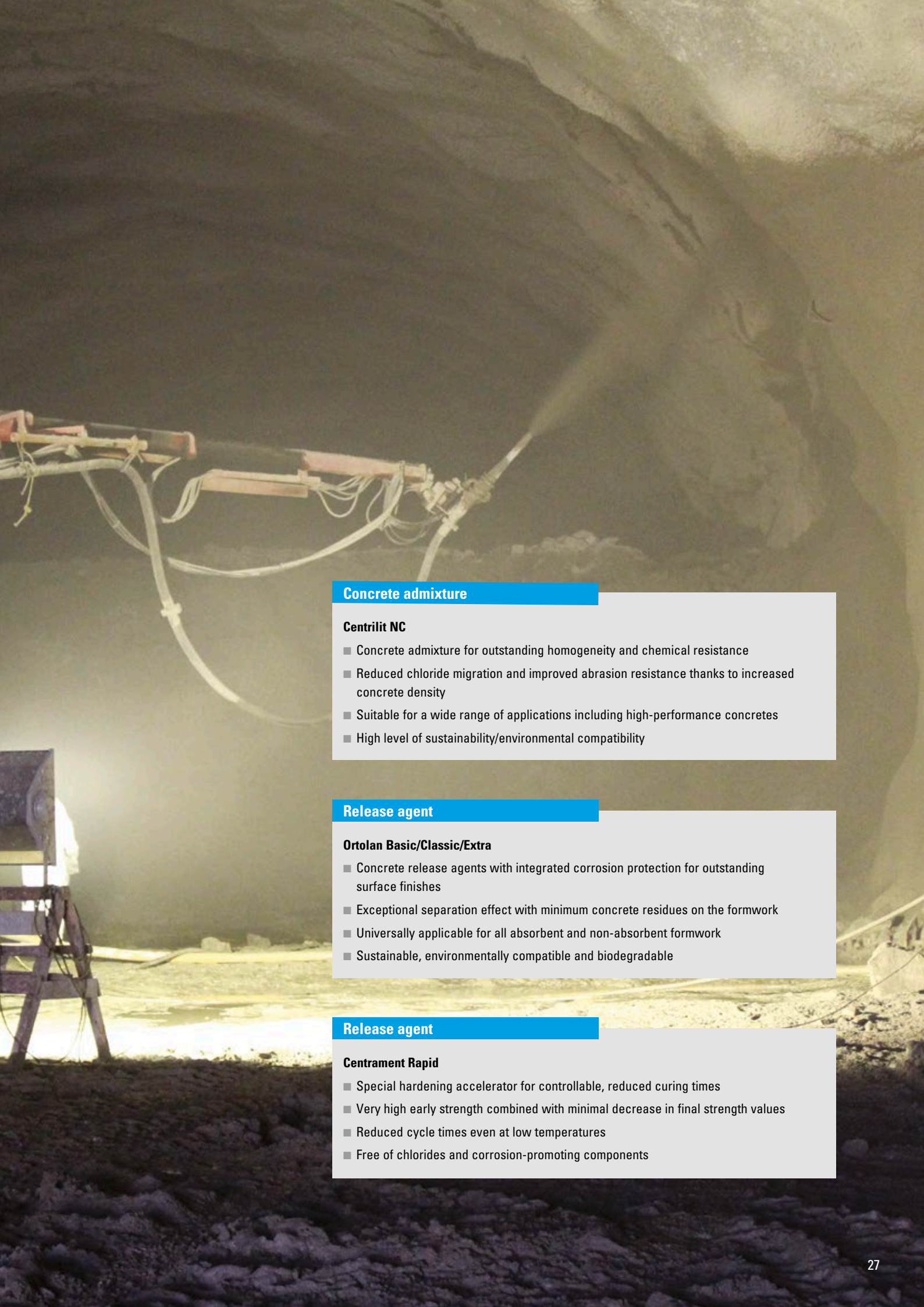

Concrete admixture

Centrilit NC

- Concrete admixture for outstanding homogeneity and chemical resistance
- Reduced chloride migration and improved abrasion resistance thanks to increased concrete density
- Suitable for a wide range of applications including high-performance concretes
- High level of sustainability/environmental compatibility

Release agent

Ortolan Basic/Classic/Extra

- Concrete release agents with integrated corrosion protection for outstanding surface finishes
- Exceptional separation effect with minimum concrete residues on the formwork
- Universally applicable for all absorbent and non-absorbent formwork
- Sustainable, environmentally compatible and biodegradable

Release agent

Centrament Rapid

- Special hardening accelerator for controllable, reduced curing times
- Very high early strength combined with minimal decrease in final strength values
- Reduced cycle times even at low temperatures
- Free of chlorides and corrosion-promoting components

Attendant Measures and Repairs

Tunnelling projects require a very high level of technical expertise, care and attention on the part of all those involved in the construction process. This applies right from the planning phase and even more so during execution of the work. Each tunnel construction project, whether carried out conventional or using mechanised tunnel boring equipment, represents a unique set of engineering challenges, with success dependent on a large number of different factors. Despite the best possible planning, high-performance technologies and optimum construction execution, problems can still arise at the driving stage, depending on the rock and soil encountered.

In such cases, attendant measures such as soil stabilisation and soil sealing and temporary shield tail sealing need to be implemented. Such activities can help sustain the required rate of advance. Damage and leakage in the tunnel lining or shell can be repaired immediately by attendant systems following the excavation.

Promptly implemented, attendant measures – such as injection, concrete repair and surface protection following the excavation – minimise the risk of structures failing or degrading. This not only reduces repair and maintenance costs in the future but also has a positive effect on the durability of the entire tunnel system.

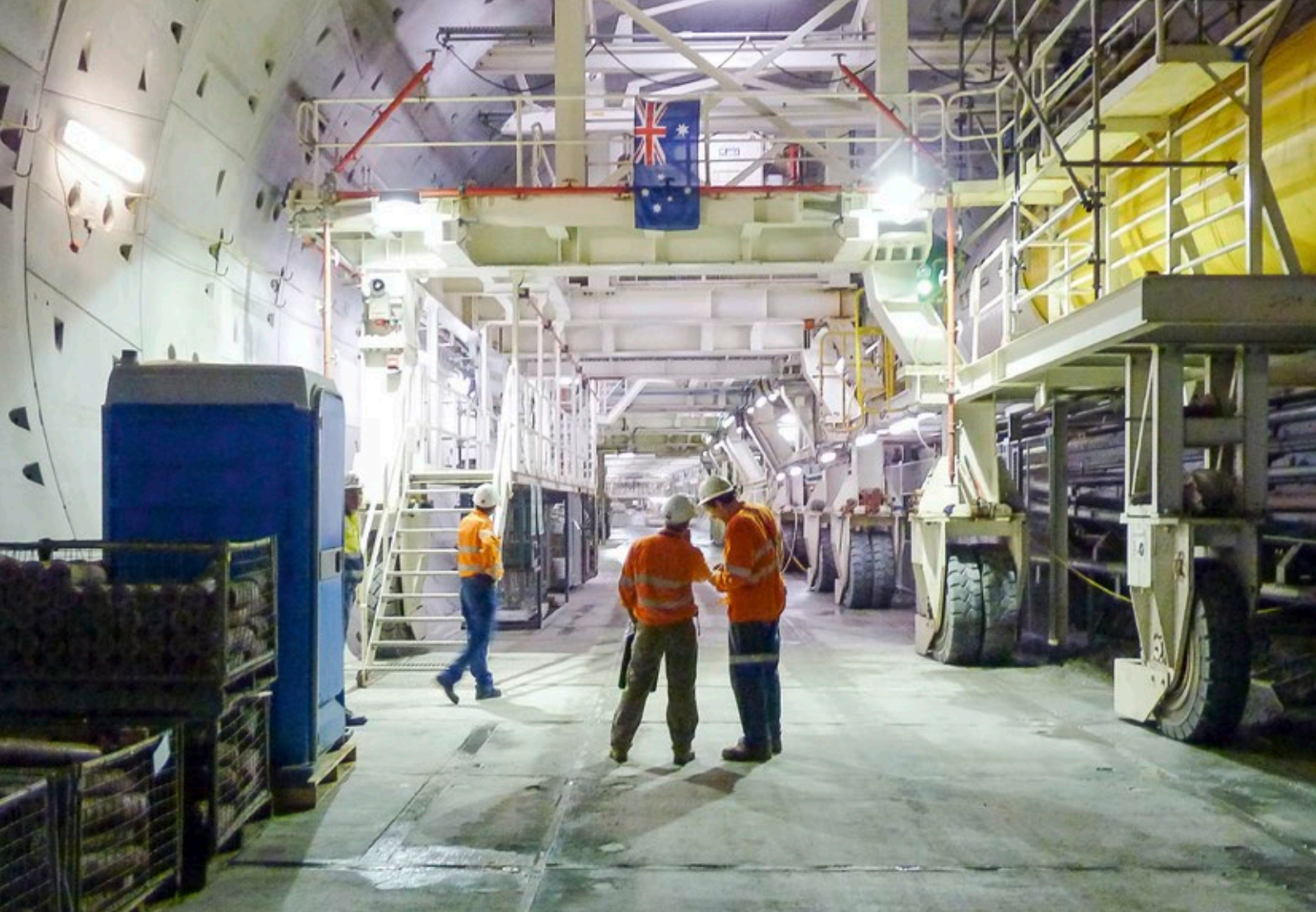

Attendant measures

Depending on the in-situ geology and the tunnel cross-section having to be cut, additional, attendant activities may accompany the excavation in order to ensure achievement of the required advance rates. Such activities may take the form of soil stabilisation or sealing.



Filling of cavities and soil consolidation

Knowledge of the geology along the tunnel axis is essential for the planning and execution of tunnel construction projects. Ensuring progress will involve both planned and ad hoc activities aligned to soil stabilisation, with the focus on filling cavities and consolidating the soil so as to achieve the required advance rate.

The objective is to stabilise the soil in critical areas. The properties of the thus consolidated strata have to ensure that here, too, high rates of advance can be achieved. In addition, any materials introduced into the in-situ soil will also need to offer full groundwater neutrality and environmental compatibility.

Organ mineral resin

MC-Montan Injekt CB

- Consolidation and sealing of soil and rock
- Optimum flow properties and short reaction times
- High compressive and tensile strength values
- Harmless to groundwater hygiene
- Organomineral formulation

Organ mineral foam

MC-Montan Injekt CF

- High expanding dry for effectively sealing and stabilising of soil and rock
- Short reaction time with significant volume increase irrespective of water presence
- Promotes optimum excavation and conveying properties of the injected soil
- Groundwater-neutral injection substance for use in dry, damp and water-filled cavities
- Optimum solution for additional shield tail sealing precautions

Duromer foam

MC-Montan Injekt LE

- Stabilises and permanently consolidates soil and rock
- High expansion ratio
- Very short reaction time and fast strength development for immediate consolidation results
- Environmentally compatible in contact with soil and groundwater

Elastomer resin

MC-Montan Injekt DR/DS

- Flexible sealing and consolidation of soil and rock
- Very low viscosity for very good injectability and penetration activity
- Water-displacing
- Sustainable and environmentally compatible in contact with soil and groundwater

Duromer resin

MC-Montan Injekt FR/FN/FS

- Resilient compound for the sealing and consolidation of soil and rock, even under high water pressure
- Optimum injectability thanks to low viscosity and controllable reaction times
- Very high compressive and tensile strength values
- Sustainable and environmentally compatible in contact with soil and groundwater

Rapid and reliable prevention of water ingress

Water is an ever-present constituent of the soil and is an important design and planning consideration for both conventional and mechanised tunnelling. Flowing and pressurised groundwater can hinder driving operations and endanger safety. Erosion of the backfill grout mortar, and water-filled gaps and cavities are among the phenomena encountered in the presence of pressurised water flows.

The solution to quickly and effectively stemming water ingress in such cases is the injection technology. For this, MC can offer a range of speciality injection resins, designed to meet the specific requirements of your project. The product systems applied have to be not only fast and reliable in their sealing capability but also groundwater-neutral and environmentally compatible.

Duromer resin

MC-Montan Injekt FR/FN/FS

- Hard elastic sealing and consolidation of soil and rock even in the presence of high water pressures
- Optimum injectability thanks to low viscosity and controllable reaction times
- Very high compressive and tensile strength
- Sustainable and environmentally compatible in contact with soil and groundwater

Elastomer resin

MC-Montan Injekt DR/DS

- Flexible sealing and consolidation of soil and rock
- Very low viscosity for very good injectability and penetration activity
- Water-displacing
- Sustainable and environmentally compatible in contact with soil and groundwater



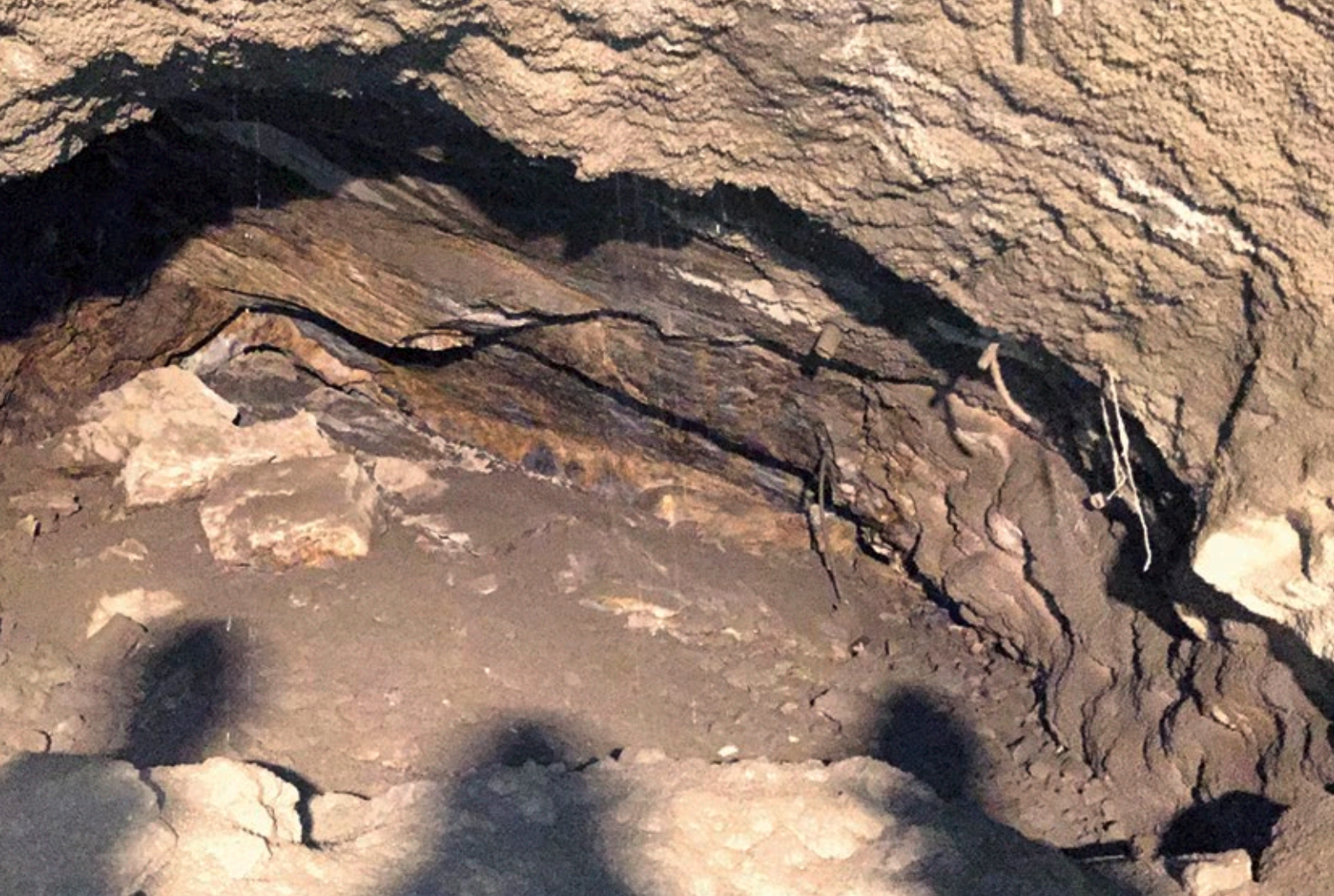

Rehabilitation

As a major factor governing asset value and durability, the damage undergone by tunnels as they are used needs to be rectified quickly and effectively. Such problems can occur throughout the tunnel's life and right from its initial construction. What all cases of damage have in common is that they require rapid response based on technically proven and utterly reliable measures, whether in the form of injection, concrete repair and reprofiling or the application of a surface protection system.



Effective sealing with swellable injection resins

Injection systems are widely used for component sealing, whether the leaks occur over a wide area, in joints or as a result of cracking. The application may involve the subsequent provision of an external waterproofing membrane, rehabilitation of leaky joints, the sealing of water-bearing cracks, or provision of a rigid seal to close off cracks and cavities in the concrete.

Where wide-area damp penetration or leaky joints are the problem, soft elastic product systems with additional security of swelling ratio serve the optimum solution. With their outstanding penetration capability in combination with exceptional bonding properties, MC's systems quickly result in successful rehabilitation, leaving the components dry, joints sealed and even waterproofing membranes effectively repaired.

Hydro-structure resin

MC-Montan Injekt TR-X

- Flexible, swelling curtain and joint sealant
- Short, controllable reaction times
- Exceptional chemical resistance even in contact with highly alkali media
- Very good formability with the additional security of exceptional swelling capacity
- Sustainable and environmentally compatible in contact with soil and groundwater

Sealing of cracks and cavities

Cracks are a normal occurrence in concrete, which means that their presence cannot be excluded either in the course of the tunnelling operation or during the service lifetime of the finished construction. Cracks become problematic where they give rise to rebar corrosion due to the ingress of water and chlorides. Such phenomena jeopardise the durability of the structure and may also reduce service lifetime.

Crack injections serve to seal, strengthen and rehabilitate damaged components. There are also product systems designed to fill and seal voids and cavities in concrete, thus returning the associated structures to full serviceability.

Injection resin

MC-Injekt 2133 flex

- Highly flexible crack sealant
- Ready-to-use one-component expansion resin
- Closed-cell structure, durably impermeable even in cracks of major width variation
- Sustainable and environmentally compatible in contact with soil and ground water

MC-Injekt 2300 rapid/2300 top

- Flexible crack sealant
- Excellent injectability
- Water displacing and pore-building
- Sustainable and environmentally compatible in contact with soil and ground water

MC-Injekt 1264 compact

- Structural rehabilitation and effective deep-crack repair
- Very good injectability and high penetration activity
- Optimum moisture compatibility
- High compressive and tensile strength with rapid strength development



This section through an injected component clearly shows the depth of penetration achieved through even the finest of hairline cracks with MC-Injekt 2133 flex



0,1

0,2

0,3



Test specimen with Nafufill KM 250
after a fire simulation



Highly fire-resistant concrete replacement system

Spalling and other concrete defects that occur in tunnel sections during excavation need to be quickly repaired in order to protect the rebar from corrosion. However, where corrosion has taken place in existing tunnels, the areas affected can also be permanently rehabilitated and protected.

In railway and road tunnels in particular, the systems employed have to offer high fire ratings. Given this imperative, particularly high-performance products – capable of keeping what they promise in an emergency – are essential for such repair work.

Concrete replacement

Nafufill KM 250

- One-component concrete replacement system for manual and spray application
- Chloride-proof and resistant to de-icing salts
- Fire resistance rating F 120 to DIN 4102-2
- Fire resistant according to the Tunnel Fire Curves issued by Germany's ZTV-ING, the EBA Code of Practice for Railway Tunnels and the TNO Report issued by the Rijkswaterstaat (RWS) of the Netherlands
- Certified to EN 1504-3, Class R4 – structurally relevant

Cooled test specimen with Nafufill KM 250 showing full fire rating compliance

Various fire loads have been specified in the form of tunnel fire curves in order to ensure and assess the fire resistance of tunnel constructions. The following temperature-time curves count among the most demanding applied:

- ZTV-ING, Part 5 Tunnel Construction, 25 minutes blaze phase at 1200 °C
- ZTV-ING, Part 5 Tunnel Construction, 55 minutes blaze phase at 1200 °C
- EBA Code, 55 minutes blaze phase at 1200 °C
- TNO Report of the RWS, 120 minutes blaze phase up to 1350 °C

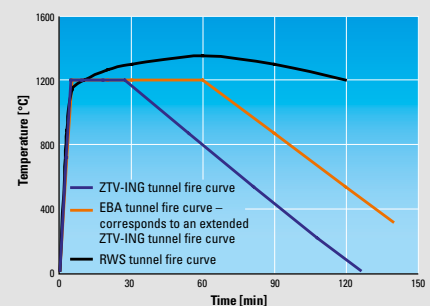

Comprehensive concrete protection with long-lasting dirt-repellent effect

Surface protection systems in tunnel constructions are required not only to perform standard functions in protecting the concrete; they also have to meet certain safety criteria, e.g. that of exhibiting a non-reflective yet bright surface so as to contribute to traffic and transit visibility.

Further requirements also include a minimal tendency towards soiling, high abrasion resistance, good cleanability and low scratchability. Appropriately high-performance products used in such applications can greatly reduce the maintenance costs of a tunnel.

Surface protection

MC-Color Flair vision

- Certified surface protection for traffic constructions
- Pigmented coating with integrated easy-to-clean technology
- Resistant to temperature, frost and de-icing salts
- Resistant to UV and weathering

Fine filler

Nafufill KM 103

- Fine filler for substrate preparation
- No post-curing required
- Very high water retention
- Class R1 and R2 to EN 1504 Part 3







Technical site support and expert advice

Every tunnel is an individual construction with its own special challenges. So it goes without saying for MC that we need to work together with our customers in order to develop individual system solutions tailored to the specific requirements of the job in hand – and thereafter to support the product application phase. You can build on the comprehensive consultancy services provided by our experts. And you can rely on our determination to secure your satisfaction and peace of mind.

Our experts will also travel to your site in order to provide you with any individual advice, support and specialist knowledge that you may need.

Product Systems for Tunnel Construction

- Soil conditioning systems
- Sealants and lubricants for shield-type TBMs
- Backfill grout mortars
- Concrete admixtures
- Release agents and formwork oils
- Soil stabilisation systems
- Injection systems
- Concrete repair systems
- Surface protection systems
- Sealing and waterproofing systems

MC-Bauchemie Müller GmbH & Co. KG
Tunnelling
Am Kruppwald 1-8
46238 Bottrop
Germany

Phone: +49 2041 101-50
Fax: +49 2041 101-588

tunnelling@mc-bauchemie.com
www.mc-bauchemie.com



BE SURE. BUILD SURE.

Contact details

